

212.M0.077

Checking trap for basin, back inspection, without drain - finish
Carbon Satin



FEATURES

Material **Brass**

TECHNICAL DRAWING

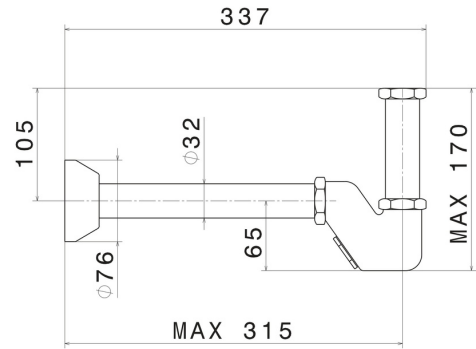





212.M0.077

Checking trap for basin, back inspection, without drain - finish Carbon Satin

AVAILABLE FINISHES

 **M0.077**
Carbon Satin

 **01.014**
finish Matt White

 **01.093**
finish Matt Black

 **21.018**
finish Chrome

 **47.083**
finish Groove Bronze

 **59.066**
finish PVD Brushed steel

 **61.020**
finish PVD Glossy Gold

 **M0.070**
finish Titanium Satin

 **M0.071**
finish Gold Satin

 **M0.072**
finish Copper Satin

 **M0.075**
finish Copper Glossy