

67638E.M0.070

Concealed thermostatic mixer, with one handle for temperature control and 2 ways out diverter. External part - finish Titanium Satin

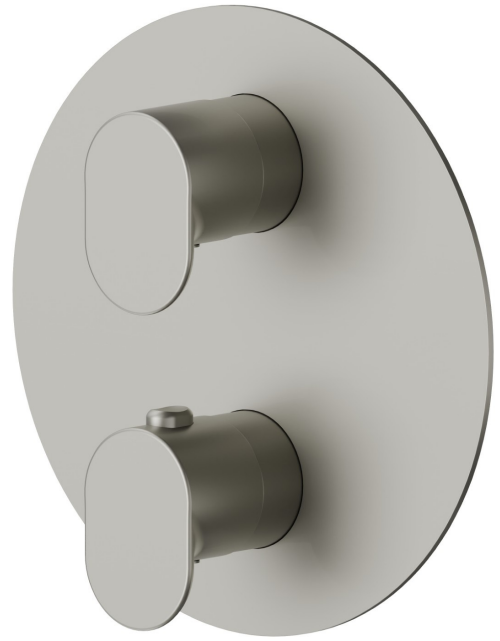

FEATURES

Material	Brass
Installation	Wall concealed part
Control type	Single lever
Diverter type	Mechanic diverter
Outlets	2 Ways Out
Water mixing	Thermostatic

Required for installation	<u>27888.00.000</u>
Required for installation	<u>31020.00.000</u>
Required for installation	<u>31061.00.000</u>

TECHNICAL DRAWING

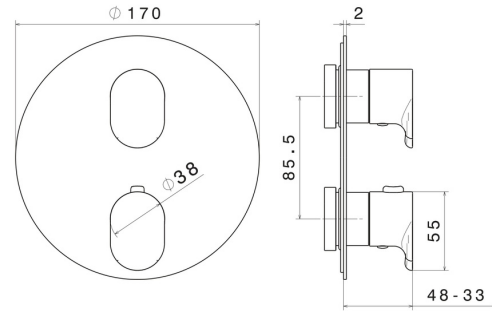





67638E.M0.070

Concealed thermostatic mixer, with one handle for temperature control and 2 ways out diverter.
External part - finish Titanium Satin

AVAILABLE FINISHES

 **M0.070**
Titanium Satin

 **01.014**
finish Matt White

 **01.093**
finish Matt Black

 **21.018**
finish Chrome

 **M0.071**
finish Gold Satin

 **M0.072**
finish Copper Satin

 **M0.075**
finish Copper Glossy