

# SENSITIVE

## 66703.M0.075

Wall-mounted electronic remote control, matching freestanding, wall or ceiling mounted device - finish Copper Glossy

With stop valves to regulate flow and temperature. Infrared controller with manually 'ON-OFF' opening, equipped with security stop at 30 seconds. External part.

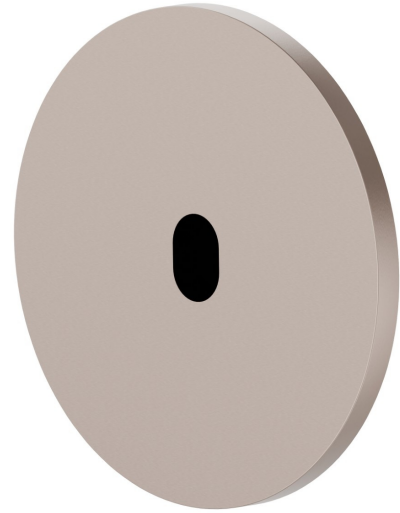

### FEATURES

Material	<b>Brass</b>
Installation	<b>Wall mounted</b>
Control type	<b>Electronic remote control</b>
Required for installation	<b><u>31073.00.000</u></b>

### TECHNICAL DRAWING

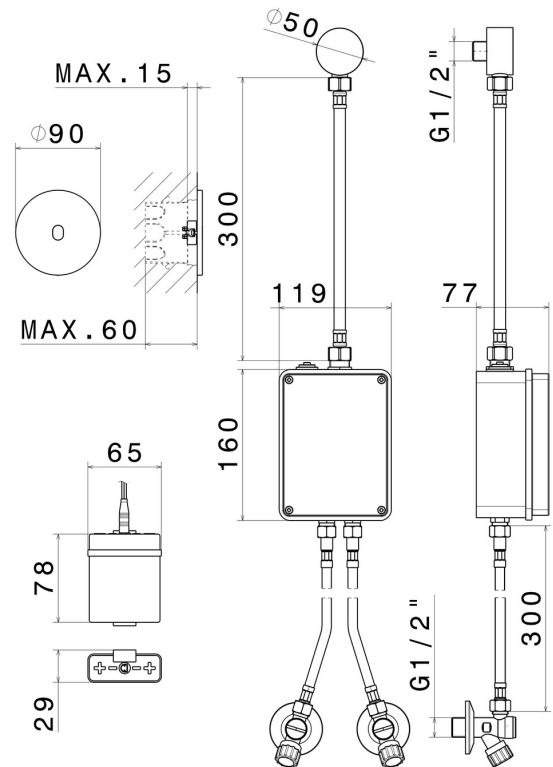

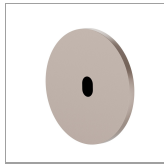

**SENSITIVE**

**66703.M0.075**

Wall-mounted electronic remote control, matching freestanding, wall or ceiling mounted device - finish Copper Glossy

**AVAILABLE FINISHES**

---



**M0.075**

Copper Glossy



**01.014**

finish Matt White



**01.093**

finish Matt Black



**21.018**

finish Chrome



**47.083**

finish Groove Bronze



**58.061**

finish PVD Copper Bronze



**58.063**

finish PVD Gun Metal



**59.064**

finish PVD Brushed Gun Metal



**59.066**

finish PVD Brushed steel



**59.067**

finish PVD Brushed Copper Bronze



**59.097**

finish PVD Brushed Gold



**59.098**

finish PVD Brushed Pale Gold

 **61.020**  
finish PVD Glossy Gold

 **M0.070**  
finish Titanium Satin

 **M0.071**  
finish Gold Satin

 **M0.072**  
finish Copper Satin

 **M0.077**  
finish Carbon Satin