

SENSITIVE

66704.47.083

Wall-mounted electronic remote control, matching freestanding, wall or ceiling mounted device - finish Groove Bronze

With stop valves to regulate flow and temperature. Infrared controller with manually 'ON-OFF' opening, equipped with security stop at 30 seconds. External part.



Groove Bronze



FEATURES

Material	Brass
Installation	Wall mounted
Control type	Electronic remote control
Required for installation	<u>31073.00.000</u>

TECHNICAL DRAWING

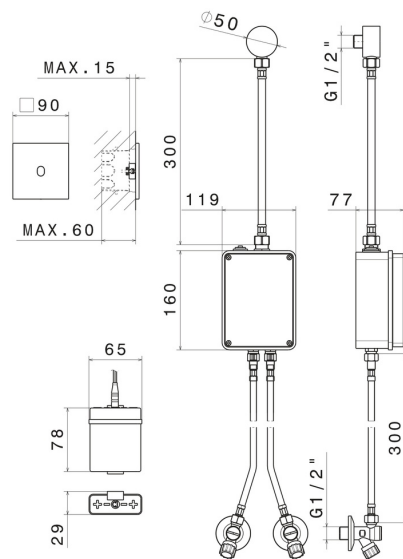

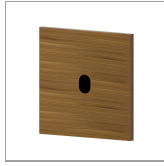

SENSITIVE

66704.47.083

Wall-mounted electronic remote control, matching freestanding, wall or ceiling mounted device - finish Groove Bronze

AVAILABLE FINISHES



47.083

Groove Bronze



01.014

finish Matt White



01.093

finish Matt Black



21.018

finish Chrome



58.061

finish PVD Copper Bronze



58.063

finish PVD Gun Metal



59.064

finish PVD Brushed Gun Metal



59.066

finish PVD Brushed steel



59.067

finish PVD Brushed Copper Bronze



59.097

finish PVD Brushed Gold



59.098

finish PVD Brushed Pale Gold



61.020

finish PVD Glossy Gold

 **M0.070**
finish Titanium Satin

 **M0.071**
finish Gold Satin

 **M0.072**
finish Copper Satin

 **M0.075**
finish Copper Glossy

 **M0.077**
finish Carbon Satin