

O'RAMA

68437.M0.070

Bocca di erogazione a parete per lavabo con attacco da 1/2" -
finitura Titanium Satin

L=190 mm

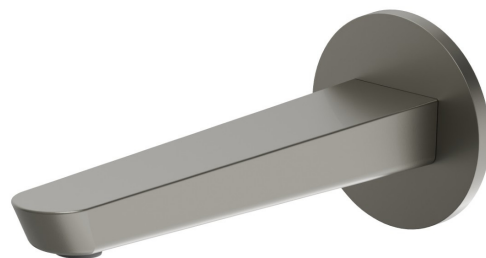

CARATTERISTICHE

Materiale	Ottone
Tecnologia	Save Water
Installazione	A parete

DISEGNO TECNICO

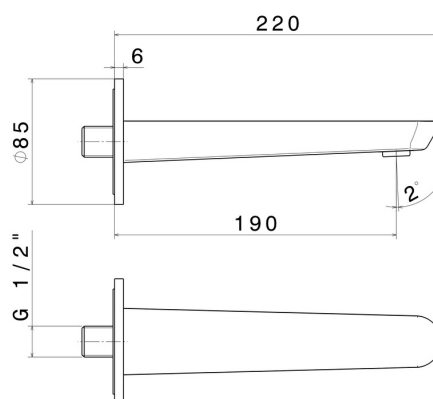



O'RAMA

68437.M0.070

Bocca di erogazione a parete per lavabo con attacco da 1/2" - finitura Titanium Satin

FINITURE DISPONIBILI

 **M0.070**
Titanium Satin

 **01.093**
finitura Nero opaco

 **21.018**
finitura Cromo

 **61.020**
finitura PVD Glossy Gold

 **M0.071**
finitura Gold Satin

 **M0.072**
finitura Copper Satin

 **M0.075**
finitura Copper Glossy