

B-EASY

72637.M0.072

Bocca di erogazione a parete per lavabo con attacco da 1/2" -
finitura Copper Satin

L=190 mm



SAVE
WATER



Copper Satin

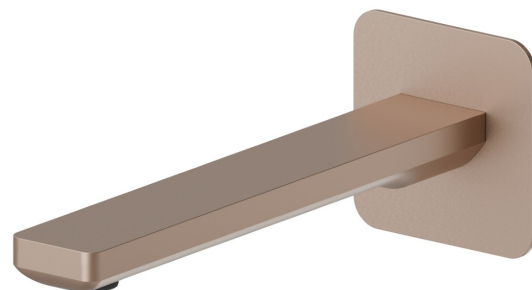

CARATTERISTICHE

Materiale

Ottone

Tecnologia

Save Water

Installazione

A parete

Tipo di foro

Monoforo

DISEGNO TECNICO

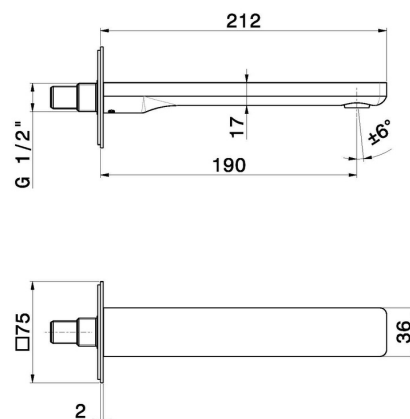



B-EASY

72637.M0.072

Bocca di erogazione a parete per lavabo con attacco da 1/2" - finitura Copper Satin

FINITURE DISPONIBILI

 **M0.072**
Copper Satin

 **01.014**
finitura Bianco opaco

 **01.093**
finitura Nero opaco

 **21.018**
finitura Cromo

 **M0.070**
finitura Titanium Satin

 **M0.071**
finitura Gold Satin

 **M0.075**
finitura Copper Glossy