

IONIKA

72838.01.093

Bocca di erogazione a parete per lavabo con raccordo speciale da 1/2" da pre-incassare - finitura Nero opaco

L=230 mm

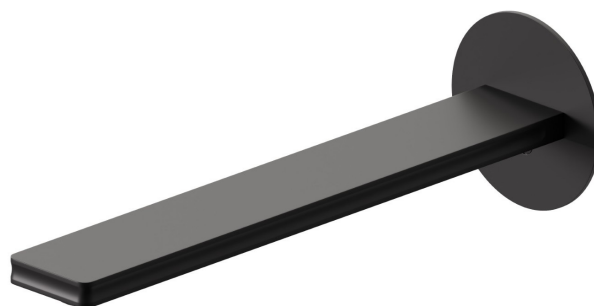

CARATTERISTICHE

Materiale	Ottone
Tecnologia	Save Water
Installazione	A parete
Tipo di foro	Monoforo

DISEGNO TECNICO

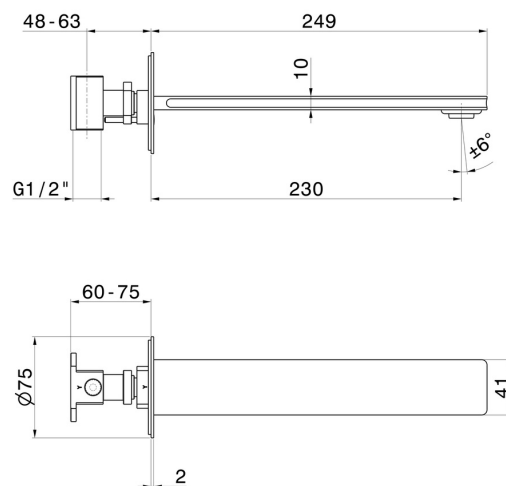



IONIKA

72838.01.093

Bocca di erogazione a parete per lavabo con raccordo speciale da 1/2" da pre-incassare -
finitura Nero opaco

FINITURE DISPONIBILI



01.093

Nero opaco



01.014

finitura Bianco opaco



21.018

finitura Cromo



59.064

finitura PVD Brushed Gun Metal



59.066

finitura PVD Acciaio Spazzolato



59.067

finitura PVD Brushed Copper Bronze



59.098

finitura PVD Brushed Pale Gold



61.020

finitura PVD Glossy Gold