

IONIKA

72838.59.066

Bocca di erogazione a parete per lavabo con raccordo speciale da 1/2" da pre-incassare - finitura PVD Acciaio Spazzolato

L=230 mm



PVD Acciaio Spazzolato



CARATTERISTICHE

Materiale

Ottone

Tecnologia

Save Water

Installazione

A parete

Tipo di foro

Monoforo

DISEGNO TECNICO

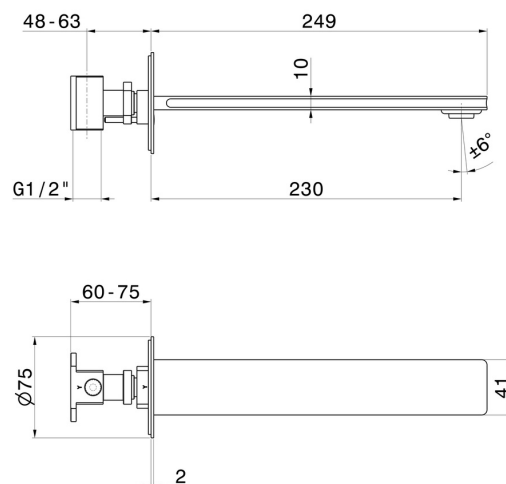



IONIKA

72838.59.066

Bocca di erogazione a parete per lavabo con raccordo speciale da 1/2" da pre-incassare -
finitura PVD Acciaio Spazzolato

FINITURE DISPONIBILI



59.066

PVD Acciaio Spazzolato



01.014

finitura Bianco opaco



01.093

finitura Nero opaco



21.018

finitura Cromo



59.064

finitura PVD Brushed Gun Metal



59.067

finitura PVD Brushed Copper Bronze



59.098

finitura PVD Brushed Pale Gold



61.020

finitura PVD Glossy Gold