

IONIKA

72838.61.020

Bocca di erogazione a parete per lavabo con raccordo speciale da 1/2" da pre-incassare - finitura PVD Glossy Gold

L=230 mm



PVD Glossy Gold



CARATTERISTICHE

Materiale

Ottone

Tecnologia

Save Water

Installazione

A parete

Tipo di foro

Monoforo

DISEGNO TECNICO

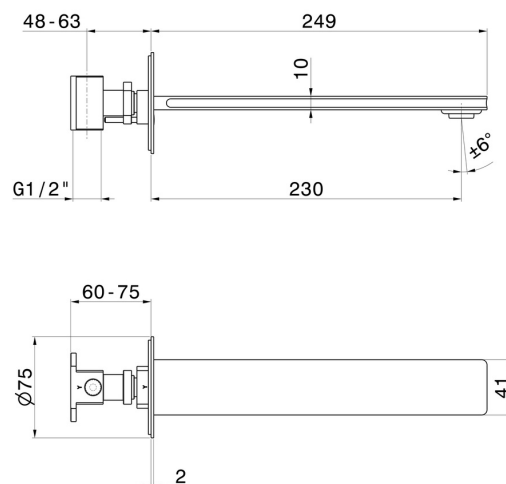



IONIKA

72838.61.020

Bocca di erogazione a parete per lavabo con raccordo speciale da 1/2" da pre-incassare -
finitura PVD Glossy Gold

FINITURE DISPONIBILI



61.020

PVD Glossy Gold



01.014

finitura Bianco opaco



01.093

finitura Nero opaco



21.018

finitura Cromo



59.064

finitura PVD Brushed Gun Metal



59.066

finitura PVD Acciaio Spazzolato



59.067

finitura PVD Brushed Copper Bronze



59.098

finitura PVD Brushed Pale Gold