

PARK L.E.

69707.05.093

Gruppo lavabo 3 fori. Attacco piantana da 1/2" - finitura
Chrome - Matt Black

Bocca bassa



Chrome - Matt Black



CARATTERISTICHE

Materiale

Ottone

Installazione

Da appoggio

Tipo di foro

3 fori

Miscelazione dell' acqua

Meccanica

DISEGNO TECNICO

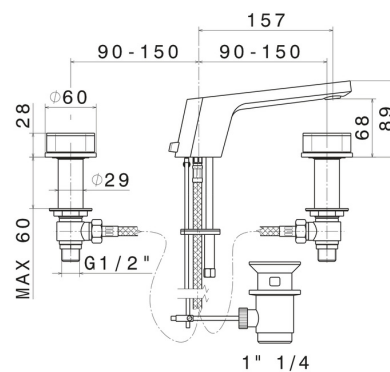



PARK L.E.

69707.05.093

Gruppo lavabo 3 fori. Attacco piantana da 1/2" - finitura Chrome - Matt Black

FINITURE DISPONIBILI



05.093

Chrome - Matt Black



62.093

finitura PVD Glossy Gold - Matt Black