

69474E.M0.072

Miscelatore monocomando ad incasso con deviatore meccanico a 2 uscite, ingressi ed uscite da 1/2". Parte esterna. Ø70 - finitura Copper Satin

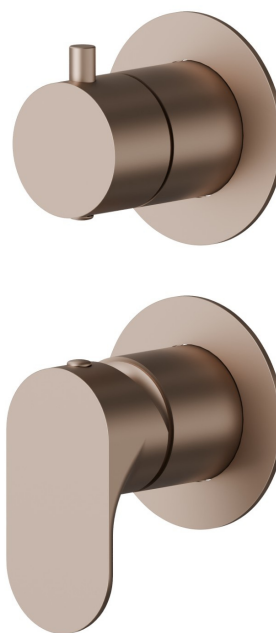

CARATTERISTICHE

Materiale	Ottone
Installazione	Incasso a parete
Tipologia di comando	Monocomando
Tipologia deviatore	Con deviatore Meccanico
Uscite	2 Uscite
Necessari per l'installazione	<u>31087.00.000</u>

DISEGNO TECNICO

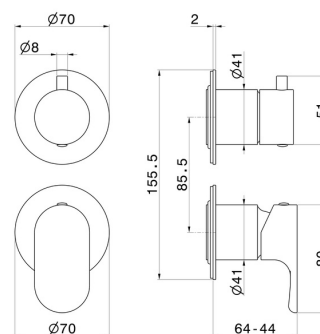

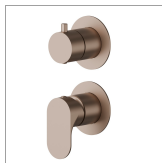



69474E.M0.072

Miscelatore monocomando ad incasso con deviatore meccanico a 2 uscite, ingressi ed uscite da 1/2". Parte esterna. Ø70 - finitura Copper Satin

FINITURE DISPONIBILI

 **M0.072**
Copper Satin

 **01.014**
finitura Bianco opaco

 **01.093**
finitura Nero opaco

 **21.018**
finitura Cromo

 **M0.070**
finitura Titanium Satin

 **M0.071**
finitura Gold Satin

 **M0.075**
finitura Copper Glossy