

XT

4200.M0.071

Miscelatore monocomando per lavabo - finitura Gold Satin



Gold Satin



CARATTERISTICHE

Materiale	Ottone
Tecnologia	Low Lead - Save Water
Installazione	Da appoggio
Versione	Standard
Tipo di foro	Monoforo
Tipologia di comando	Monocomando
Scarico	Con scarico
Miscelazione dell' acqua	Meccanica

DISEGNO TECNICO

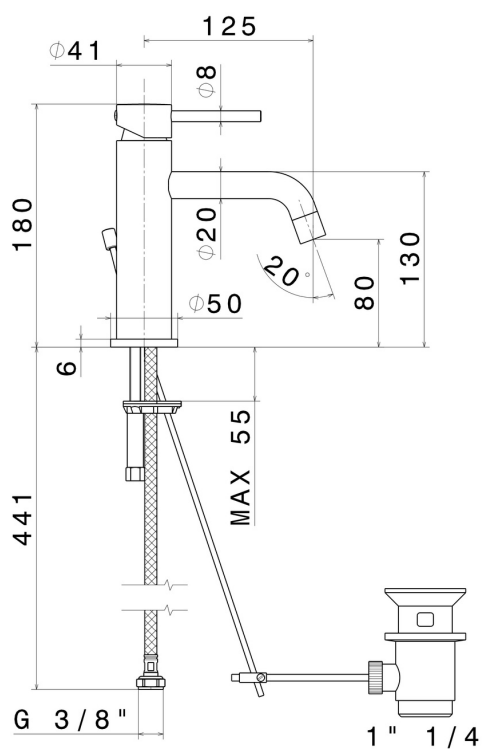



XT

4200.M0.071

Miscelatore monocomando per lavabo - finitura Gold Satin

FINITURE DISPONIBILI

 **M0.071**
Gold Satin

 **01.014**
finitura Bianco opaco

 **01.093**
finitura Nero opaco

 **21.018**
finitura Cromo

 **58.061**
finitura PVD Copper Bronze

 **58.063**
finitura PVD Gun Metal

 **61.020**
finitura PVD Glossy Gold

 **M0.070**
finitura Titanium Satin

 **M0.072**
finitura Copper Satin

 **M0.075**
finitura Copper Glossy

 **M0.077**
finitura Carbon Satin