

MAKI

71822.59.066

Miscelatore monocomando per lavello con bocca "L" girevole
- finitura PVD Acciaio Spazzolato



PVD Acciaio Spazzolato



CARATTERISTICHE

Materiale	Ottone
Tecnologia	Energy Saving - Low Lead - Save Water
Installazione	Da appoggio
Canna miscelatore cucina	Canna a "L" - Canna girevole
Tipologia di comando	Monocomando

DISEGNO TECNICO

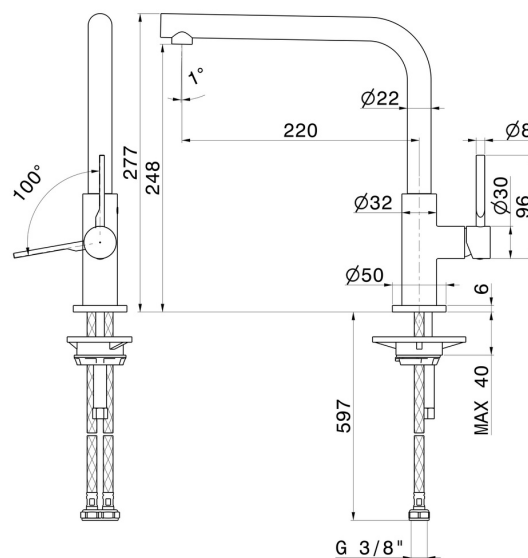



MAKI

71822.59.066

Miscelatore monocomando per lavello con bocca "L" girevole - finitura PVD Acciaio Spazzolato

FINITURE DISPONIBILI



59.066

PVD Acciaio Spazzolato



01.093

finitura Nero opaco



21.018

finitura Cromo



31.028

finitura Cromo Spazzolato



59.064

finitura PVD Brushed Gun Metal



59.067

finitura PVD Brushed Copper Bronze



59.098

finitura PVD Brushed Pale Gold



M0.077

finitura Carbon Satin