

70437E.59.097

Miscelatore termostatico ad incasso a 3 uscite, con comando per la regolazione della temperatura e pulsanti on/off. Parte esterna - finitura PVD Brushed Gold

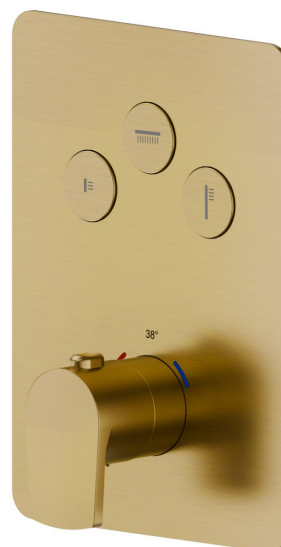

CARATTERISTICHE

Materiale	Ottone
Installazione	Incasso a parete
Uscite	3 Uscite
Miscelazione dell' acqua	Termostatica
Necessari per l'installazione	<u>27752.00.000</u>

DISEGNO TECNICO

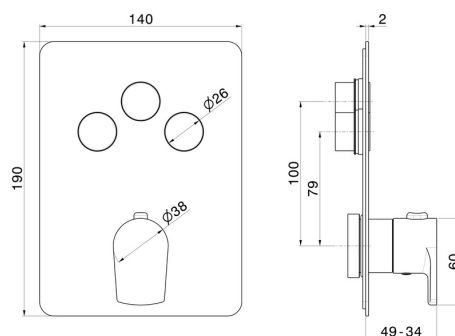



70437E.59.097

Miscelatore termostatico ad incasso a 3 uscite, con comando per la regolazione della temperatura e pulsanti on/off. Parte esterna - finitura PVD Brushed Gold

FINITURE DISPONIBILI



59.097

PVD Brushed Gold



01.014

finitura Bianco opaco



01.093

finitura Nero opaco



21.018

finitura Cromo



59.064

finitura PVD Brushed Gun Metal



59.066

finitura PVD Acciaio Spazzolato



59.067

finitura PVD Brushed Copper Bronze