

70440E.05.093

Miscelatore termostatico ad incasso a 3 uscite, con comando per la regolazione della temperatura e pulsanti on/off. Parte esterna - finitura Chrome - Matt Black



Chrome - Matt Black



CARATTERISTICHE

Materiale	Ottone
Installazione	Incasso a parete
Uscite	3 Uscite
Miscelazione dell' acqua	Termostatica
Necessari per l'installazione	<u>27752.00.000</u>

DISEGNO TECNICO

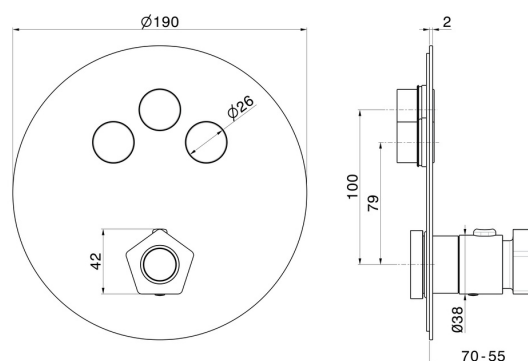



70440E.05.093

Miscelatore termostatico ad incasso a 3 uscite, con comando per la regolazione della temperatura e pulsanti on/off. Parte esterna - finitura Chrome - Matt Black

FINITURE DISPONIBILI



05.093

Chrome - Matt Black



62.093

finitura PVD Glossy Gold - Matt Black