

70440E.62.093

Miscelatore termostatico ad incasso a 3 uscite, con comando per la regolazione della temperatura e pulsanti on/off. Parte esterna - finitura PVD Glossy Gold - Matt Black

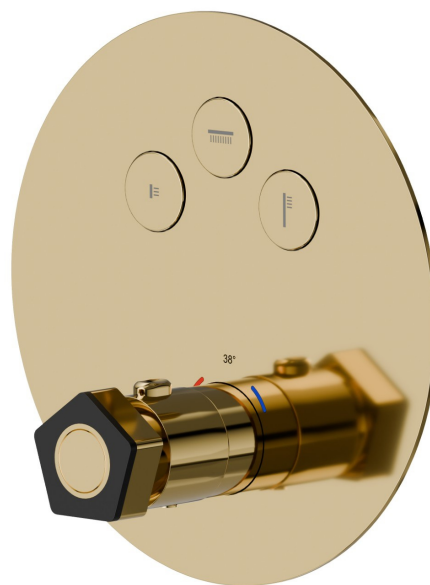

PVD Glossy Gold - Matt Black



CARATTERISTICHE

Materiale	Ottone
Installazione	Incasso a parete
Uscite	3 Uscite
Miscelazione dell' acqua	Termostatica
Necessari per l'installazione	<u>27752.00.000</u>

DISEGNO TECNICO

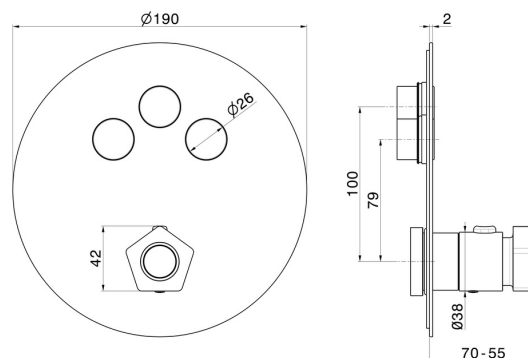

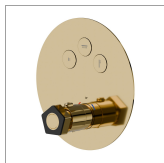

70440E.62.093

Miscelatore termostatico ad incasso a 3 uscite, con comando per la regolazione della temperatura e pulsanti on/off. Parte esterna - finitura PVD Glossy Gold - Matt Black

FINITURE DISPONIBILI



62.093

PVD Glossy Gold - Matt Black



05.093

finitura Chrome - Matt Black