

## 67638E.M0.071

Miscelatore termostatico ad incasso, con comando per la regolazione della temperatura e deviatore a 2 uscite. Parte esterna - finitura Gold Satin



### CARATTERISTICHE

Materiale	<b>Ottone</b>
Installazione	<b>Incasso a parete</b>
Tipologia di comando	<b>Monocomando</b>
Tipologia deviatore	<b>Con deviatore Meccanico</b>
Uscite	<b>2 Uscite</b>
Miscelazione dell' acqua	<b>Termostatica</b>
Necessari per l'installazione	<b><u>27888.00.000</u></b>
Necessari per l'installazione	<b><u>31020.00.000</u></b>
Necessari per l'installazione	<b><u>31061.00.000</u></b>

### DISEGNO TECNICO

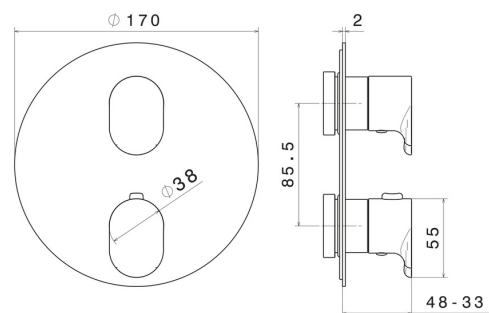

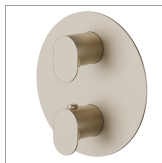

**67638E.MO.071**

Miscelatore termostatico ad incasso, con comando per la regolazione della temperatura e deviatore a 2 uscite. Parte esterna - finitura Gold Satin

**FINITURE DISPONIBILI**

---

 **MO.071**  
Gold Satin

 **01.014**  
finitura Bianco opaco

 **01.093**  
finitura Nero opaco

 **21.018**  
finitura Cromo

 **MO.070**  
finitura Titanium Satin

 **MO.072**  
finitura Copper Satin

 **MO.075**  
finitura Copper Glossy