

69857E.59.067

Miscelatore termostatico ad incasso, con comando per la regolazione della temperatura e deviatore a 2 uscite. Parte esterna. - finitura PVD Brushed Copper Bronze



PVD Brushed Copper Bronze



CARATTERISTICHE

Materiale	Ottone
Installazione	Incasso a parete
Tipologia di comando	Monocomando
Tipologia deviatore	Con deviatore Meccanico
Uscite	2 Uscite
Miscelazione dell' acqua	Termostatica
Necessari per l'installazione	<u>27888.00.000</u>
Necessari per l'installazione	<u>31020.00.000</u>
Necessari per l'installazione	<u>31061.00.000</u>

DISEGNO TECNICO

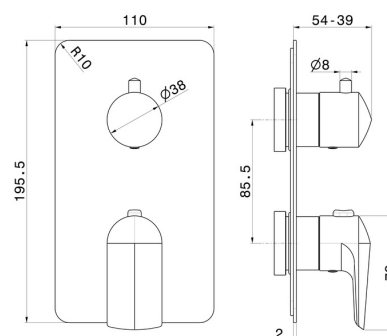





69857E.59.067

Miscelatore termostatico ad incasso, con comando per la regolazione della temperatura e deviatore a 2 uscite. Parte esterna. - finitura PVD Brushed Copper Bronze

FINITURE DISPONIBILI

 **59.067**
PVD Brushed Copper Bronze

 **01.014**
finitura Bianco opaco

 **01.093**
finitura Nero opaco

 **21.018**
finitura Cromo

 **58.061**
finitura PVD Copper Bronze

 **58.063**
finitura PVD Gun Metal

 **59.064**
finitura PVD Brushed Gun Metal

 **59.097**
finitura PVD Brushed Gold

 **61.020**
finitura PVD Glossy Gold