

73427E.58.061

Miscelatore termostatico ad incasso, da abbinare a rubinetto d'arresto. Parte esterna. Ø110. LUXURY - finitura PVD Copper Bronze

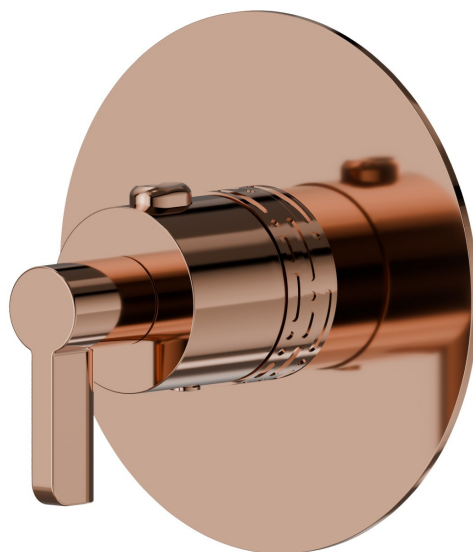

CARATTERISTICHE

Materiale	Ottone
Installazione	Incasso a parete
Uscite	1 Uscita
Miscelazione dell' acqua	Termostatica
Necessari per l'installazione	<u>27890.00.000</u>

DISEGNO TECNICO

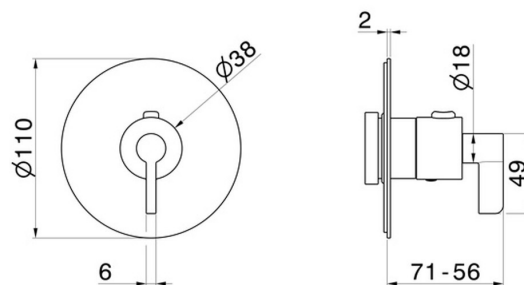

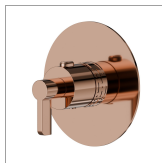



73427E.58.061

Miscelatore termostatico ad incasso, da abbinare a rubinetto d'arresto. Parte esterna. Ø110.
LUXURY - finitura PVD Copper Bronze

FINITURE DISPONIBILI

 **58.061**
PVD Copper Bronze

 **01.093**
finitura Nero opaco

 **21.018**
finitura Cromo

 **47.083**
finitura Groove Bronze

 **58.063**
finitura PVD Gun Metal

 **59.098**
finitura PVD Brushed Pale Gold

 **61.020**
finitura PVD Glossy Gold