

73404E.59.064

Miscelatore termostatico multiutenza ad incasso a 2 uscite.
ingressi ed uscite da 3/4". Parte esterna - finitura PVD Brushed
Gun Metal



CARATTERISTICHE

Materiale	Ottone/Marmo
Installazione	Incasso a parete
Uscite	2 Uscite
Miscelazione dell' acqua	Termostatica
Necessari per l'installazione	<u>31063.00.000</u>

DISEGNO TECNICO

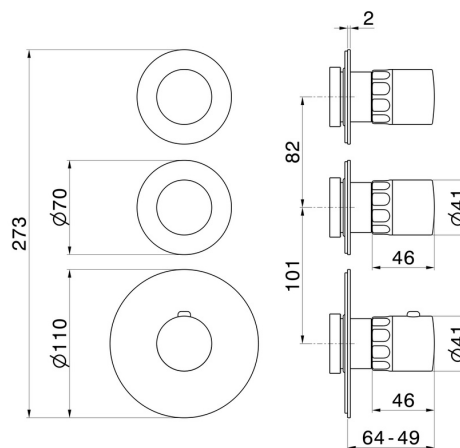



73404E.59.064

Miscelatore termostatico multiutenza ad incasso a 2 uscite. ingressi ed uscite da 3/4". Parte esterna - finitura PVD Brushed Gun Metal

FINITURE DISPONIBILI



59.064

PVD Brushed Gun Metal



01.014

finitura Bianco opaco



01.093

finitura Nero opaco



21.018

finitura Cromo



59.066

finitura PVD Acciaio Spazzolato



59.067

finitura PVD Brushed Copper Bronze



59.098

finitura PVD Brushed Pale Gold



61.020

finitura PVD Glossy Gold