

## 73405E.59.098

Miscelatore termostatico multiutenza ad incasso a 2 uscite.  
 ingressi ed uscite da 3/4". Parte esterna - finitura PVD Brushed  
 Pale Gold



### CARATTERISTICHE

Materiale	<b>Ottone/Marmo</b>
Installazione	<b>Incasso a parete</b>
Uscite	<b>2 Uscite</b>
Miscelazione dell' acqua	<b>Termostatica</b>
Necessari per l'installazione	<b><u>31063.00.000</u></b>

### DISEGNO TECNICO

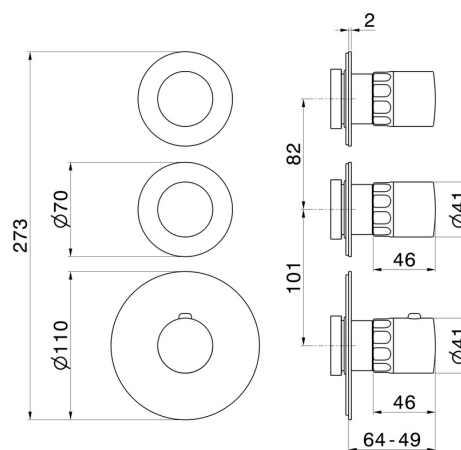

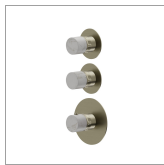

**73405E.59.098**

Miscelatore termostatico multiutenza ad incasso a 2 uscite. ingressi ed uscite da 3/4". Parte esterna - finitura PVD Brushed Pale Gold

**FINITURE DISPONIBILI**

---



**59.098**

PVD Brushed Pale Gold



**01.014**

finitura Bianco opaco



**01.093**

finitura Nero opaco



**21.018**

finitura Cromo



**59.064**

finitura PVD Brushed Gun Metal



**59.066**

finitura PVD Acciaio Spazzolato



**59.067**

finitura PVD Brushed Copper Bronze



**61.020**

finitura PVD Glossy Gold