

27853.00.000

Parte incasso. Membrana isolante - finitura Neutro



CARATTERISTICHE

Installazione

Incasso a parete

Destinazione d'uso corpo
incasso

Incasso per lavabo

DISEGNO TECNICO

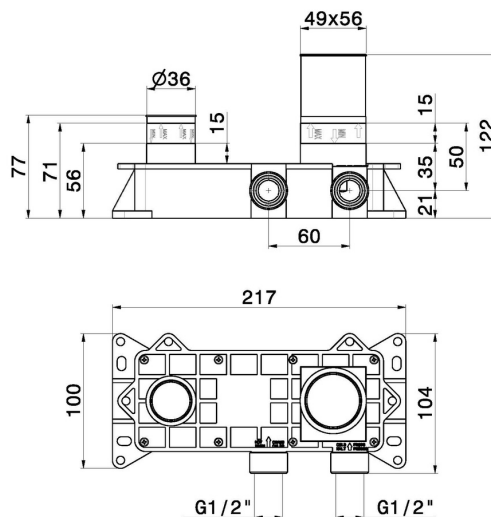



27853.00.000

Parte incasso. Membrana isolante - finitura Neutro

FINITURE DISPONIBILI



00.000

Neutro