

232.M0.072

Piletta da 1"1/4 con scarico a pulsante e troppopieno - finitura Copper Satin



CARATTERISTICHE

Materiale

Ottone

Scarico

Scarico a pulsante

DISEGNO TECNICO

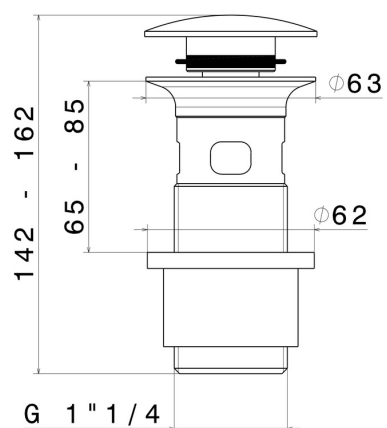

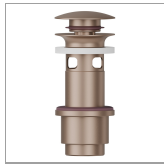

232.M0.072

Piletta da 1"1/4 con scarico a pulsante e troppopieno - finitura Copper Satin

FINITURE DISPONIBILI



M0.072

Copper Satin



01.014

finitura Bianco opaco



01.093

finitura Nero opaco



21.018

finitura Cromo



47.083

finitura Groove Bronze



58.061

finitura PVD Copper Bronze



58.063

finitura PVD Gun Metal



59.064

finitura PVD Brushed Gun Metal



59.066

finitura PVD Acciaio Spazzolato



59.067

finitura PVD Brushed Copper Bronze



59.097

finitura PVD Brushed Gold



59.098

finitura PVD Brushed Pale Gold

 **61.020**
finitura PVD Glossy Gold

 **M0.070**
finitura Titanium Satin

 **M0.071**
finitura Gold Satin

 **M0.075**
finitura Copper Glossy

 **M0.077**
finitura Carbon Satin