

228.01.093

Piletta da 1"1/4 con scarico libero - finitura Nero opaco



CARATTERISTICHE

Materiale

Ottone

Scarico

Scarico libero

DISEGNO TECNICO

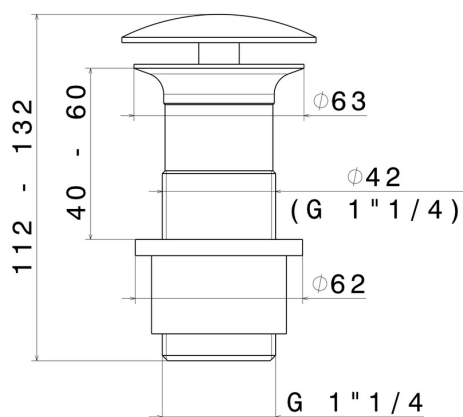



228.01.093

Piletta da 1"1/4 con scarico libero - finitura Nero opaco

FINITURE DISPONIBILI



01.093

Nero opaco



01.014

finitura Bianco opaco



21.018

finitura Cromo



47.083

finitura Groove Bronze



58.061

finitura PVD Copper Bronze



58.063

finitura PVD Gun Metal



59.064

finitura PVD Brushed Gun Metal



59.066

finitura PVD Acciaio Spazzolato



59.067

finitura PVD Brushed Copper Bronze



59.097

finitura PVD Brushed Gold



59.098

finitura PVD Brushed Pale Gold



61.020

finitura PVD Glossy Gold

 **MO.070**
finitura Titanium Satin

 **MO.071**
finitura Gold Satin

 **MO.072**
finitura Copper Satin

 **MO.075**
finitura Copper Glossy

 **MO.077**
finitura Carbon Satin