

228.58.063

Piletta da 1"1/4 con scarico libero - finitura PVD Gun Metal



CARATTERISTICHE

Materiale

Ottone

Scarico

Scarico libero

DISEGNO TECNICO

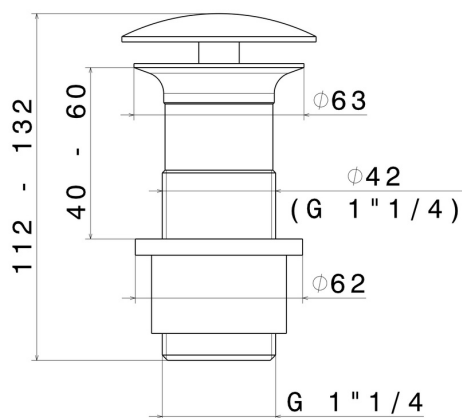



228.58.063

Piletta da 1"1/4 con scarico libero - finitura PVD Gun Metal

FINITURE DISPONIBILI



58.063

PVD Gun Metal



01.014

finitura Bianco opaco



01.093

finitura Nero opaco



21.018

finitura Cromo



47.083

finitura Groove Bronze



58.061

finitura PVD Copper Bronze



59.064

finitura PVD Brushed Gun Metal



59.066

finitura PVD Acciaio Spazzolato



59.067

finitura PVD Brushed Copper Bronze



59.097

finitura PVD Brushed Gold



59.098

finitura PVD Brushed Pale Gold



61.020

finitura PVD Glossy Gold

 **MO.070**
finitura Titanium Satin

 **MO.071**
finitura Gold Satin

 **MO.072**
finitura Copper Satin

 **MO.075**
finitura Copper Glossy

 **MO.077**
finitura Carbon Satin