

229.47.083

Piletta da 1"1/4 con scarico libero - finitura Groove Bronze



Groove Bronze



CARATTERISTICHE

Materiale

Ottone

Scarico

Scarico libero

DISEGNO TECNICO

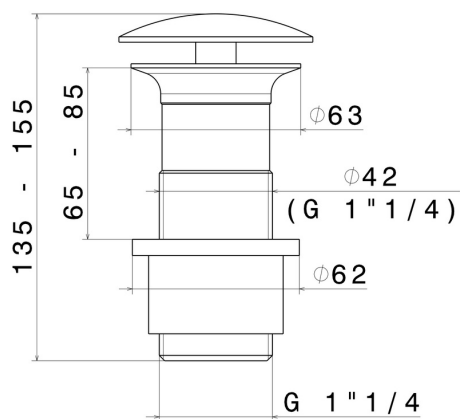



229.47.083

Piletta da 1"1/4 con scarico libero - finitura Groove Bronze

FINITURE DISPONIBILI



47.083

Groove Bronze



01.014

finitura Bianco opaco



01.093

finitura Nero opaco



21.018

finitura Cromo



58.061

finitura PVD Copper Bronze



58.063

finitura PVD Gun Metal



59.064

finitura PVD Brushed Gun Metal



59.066

finitura PVD Acciaio Spazzolato



59.067

finitura PVD Brushed Copper Bronze



59.097

finitura PVD Brushed Gold



59.098

finitura PVD Brushed Pale Gold



61.020

finitura PVD Glossy Gold

 **M0.070**
finitura Titanium Satin

 **M0.071**
finitura Gold Satin

 **M0.072**
finitura Copper Satin

 **M0.075**
finitura Copper Glossy

 **M0.077**
finitura Carbon Satin