

## 229.M0.077

Piletta da 1"1/4 con scarico libero - finitura Carbon Satin



### CARATTERISTICHE

---

Materiale

**Ottone**

Scarico

**Scarico libero**

### DISEGNO TECNICO

---

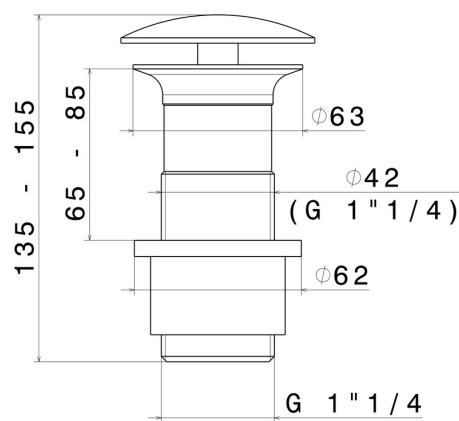



**229.M0.077**

Piletta da 1"1/4 con scarico libero - finitura Carbon Satin

## FINITURE DISPONIBILI

---



**M0.077**

Carbon Satin



**01.014**

finitura Bianco opaco



**01.093**

finitura Nero opaco



**21.018**

finitura Cromo



**47.083**

finitura Groove Bronze



**58.061**

finitura PVD Copper Bronze



**58.063**

finitura PVD Gun Metal



**59.064**

finitura PVD Brushed Gun Metal



**59.066**

finitura PVD Acciaio Spazzolato



**59.067**

finitura PVD Brushed Copper Bronze



**59.097**

finitura PVD Brushed Gold



**59.098**

finitura PVD Brushed Pale Gold

 **61.020**  
finitura PVD Glossy Gold

 **M0.070**  
finitura Titanium Satin

 **M0.071**  
finitura Gold Satin

 **M0.072**  
finitura Copper Satin

 **M0.075**  
finitura Copper Glossy