

212.59.066

Sifone per lavabo, ispezione posteriore, senza piletta - finitura PVD Acciaio Spazzolato



PVD Acciaio Spazzolato



CARATTERISTICHE

Materiale

Ottone

DISEGNO TECNICO

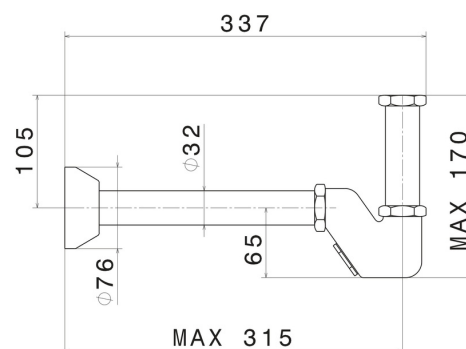





212.59.066

Sifone per lavabo, ispezione posteriore, senza piletta - finitura PVD Acciaio Spazzolato

FINITURE DISPONIBILI

 **59.066**
PVD Acciaio Spazzolato

 **01.014**
finitura Bianco opaco

 **01.093**
finitura Nero opaco

 **21.018**
finitura Cromo

 **47.083**
finitura Groove Bronze

 **61.020**
finitura PVD Glossy Gold

 **M0.070**
finitura Titanium Satin

 **M0.071**
finitura Gold Satin

 **M0.072**
finitura Copper Satin

 **M0.075**
finitura Copper Glossy

 **M0.077**
finitura Carbon Satin