

IONIKA

72838.59.067

Bec mural pour lavabo avec raccordement spécial 1/2" à pré-intégrer - finition PVD Brushed Copper Bronze

L=230 mm



PVD Brushed Copper Bronze

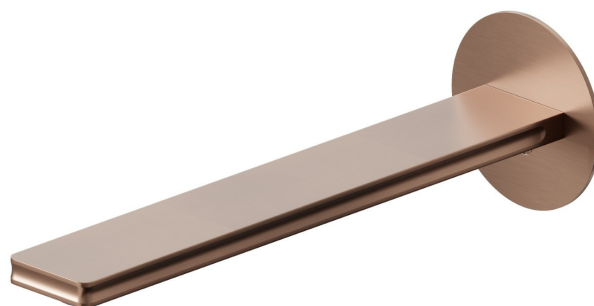

CARACTÉRISTIQUES

Matériau	Laiton
Technologie	Save Water
Installation	Murale
Type de perçage	Monotrou

DESSIN TECHNIQUE

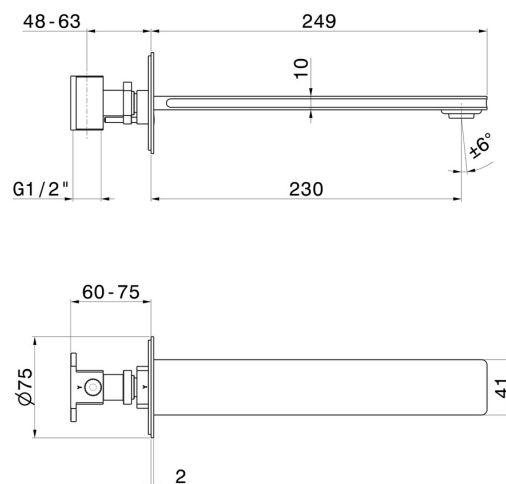



IONIKA

72838.59.067

Bec mural pour lavabo avec raccordement spécial 1/2" à pré-intégrer - finition PVD Brushed Copper Bronze

FINITIONS DISPONIBLES



59.067

PVD Brushed Copper Bronze



01.014

finition Matt White



01.093

finition Matt Black



21.018

finition Chrome



59.064

finition PVD Brushed Gun Metal



59.066

finition PVD Brushed steel



59.098

finition PVD Brushed Pale Gold



61.020

finition PVD Glossy Gold