

27853.00.000

Boîte d'encastrement isolée - finition Neutral



CARACTÉRISTIQUES

Installation

Boîte d'encastrement mural

Destination du corps encastré

**Boîte d'encastrement pour
lavabo**

DESSIN TECHNIQUE

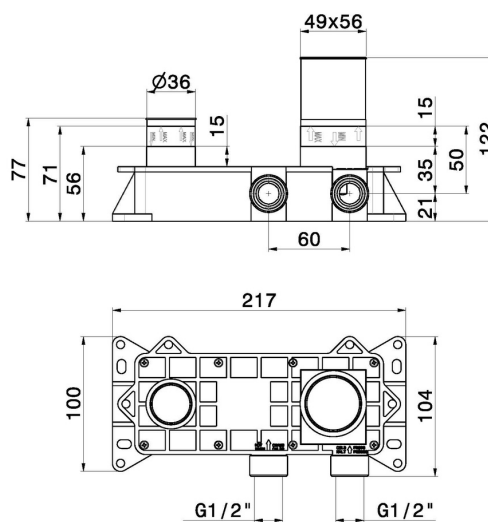



27853.00.000

Boîte d'encastrement isolée - finition Neutral

FINITIONS DISPONIBLES



00.000

Neutral