

229.M0.071

Bonde d'évacuation libre 1"1/4 - finition Gold Satin

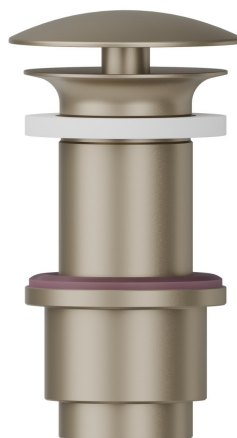

CARACTÉRISTIQUES

Matériau

Laiton

Vidage

Bonde d'évacuation libre

DESSIN TECHNIQUE

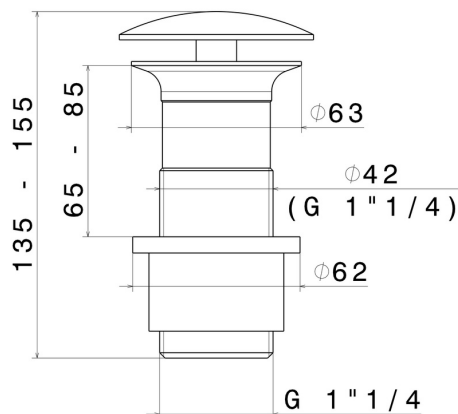

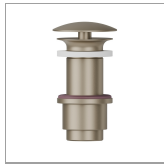

229.M0.071

Bonde d'évacuation libre 1"1/4 - finition Gold Satin

FINITIONS DISPONIBLES



M0.071

Gold Satin



01.014

finition Matt White



01.093

finition Matt Black



21.018

finition Chrome



47.083

finition Groove Bronze



58.061

finition PVD Copper Bronze



58.063

finition PVD Gun Metal



59.064

finition PVD Brushed Gun Metal



59.066

finition PVD Brushed steel



59.067

finition PVD Brushed Copper Bronze



59.097

finition PVD Brushed Gold



59.098

finition PVD Brushed Pale Gold



61.020

finish PVD Glossy Gold



M0.070

finish Titanium Satin



M0.072

finish Copper Satin



M0.075

finish Copper Glossy



M0.077

finish Carbon Satin