

## 229.M0.075

Bonde d'évacuation libre 1"1/4 - finition Copper Glossy

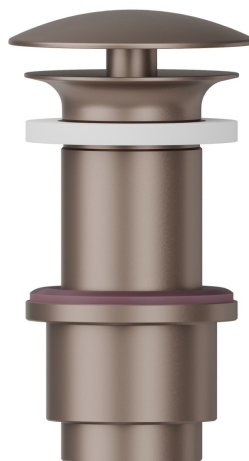

### CARACTÉRISTIQUES

Matériau	<b>Laiton</b>
Vidage	<b>Bonde d'évacuation libre</b>

### DESSIN TECHNIQUE

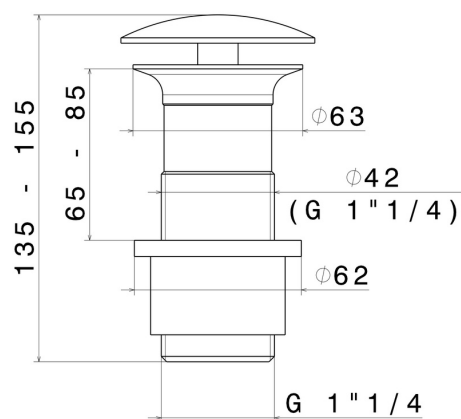

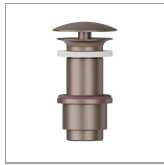

**229.M0.075**

Bonde d'évacuation libre 1"1/4 - finition Copper Glossy

## FINITIONS DISPONIBLES

---



**M0.075**

Copper Glossy



**01.014**

finition Matt White



**01.093**

finition Matt Black



**21.018**

finition Chrome



**47.083**

finition Groove Bronze



**58.061**

finition PVD Copper Bronze



**58.063**

finition PVD Gun Metal



**59.064**

finition PVD Brushed Gun Metal



**59.066**

finition PVD Brushed steel



**59.067**

finition PVD Brushed Copper Bronze



**59.097**

finition PVD Brushed Gold



**59.098**

finition PVD Brushed Pale Gold

 **61.020**  
finition PVD Glossy Gold

 **M0.070**  
finition Titanium Satin

 **M0.071**  
finition Gold Satin

 **M0.072**  
finition Copper Satin

 **M0.077**  
finition Carbon Satin