

229.M0.077

Bonde d'évacuation libre 1"1/4 - finition Carbon Satin



CARACTÉRISTIQUES

Matériau

Laiton

Vidage

Bonde d'évacuation libre

DESSIN TECHNIQUE

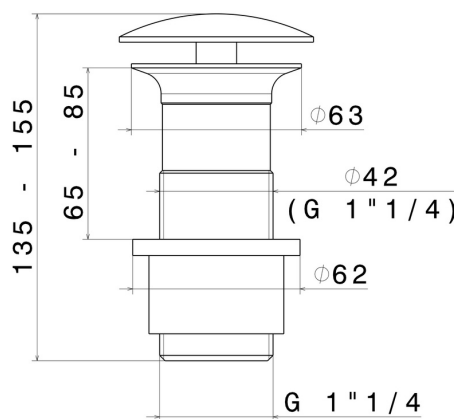



229.M0.077

Bonde d'évacuation libre 1"1/4 - finition Carbon Satin

FINITIONS DISPONIBLES



M0.077

Carbon Satin



01.014

finition Matt White



01.093

finition Matt Black



21.018

finition Chrome



47.083

finition Groove Bronze



58.061

finition PVD Copper Bronze



58.063

finition PVD Gun Metal



59.064

finition PVD Brushed Gun Metal



59.066

finition PVD Brushed steel



59.067

finition PVD Brushed Copper Bronze



59.097

finition PVD Brushed Gold



59.098

finition PVD Brushed Pale Gold

 **61.020**
finition PVD Glossy Gold

 **M0.070**
finition Titanium Satin

 **M0.071**
finition Gold Satin

 **M0.072**
finition Copper Satin

 **M0.075**
finition Copper Glossy