

# SENSITIVE

**66704.59.098**

Commande électronique murale, compatible avec un dispositif à poser, mural ou au plafond - finition PVD Brushed Pale Gold

Réglage de la température et du débit avec robinets d'arrêt (inclus).

Commande d'ouverture à infrarouge ON-OFF manuelle, arrêt programmé à 30". Façade murale.



PVD Brushed Pale Gold



## CARACTÉRISTIQUES

Matériau	<b>Laiton</b>
Installation	<b>Murale</b>
Type de commande	<b>Commande électronique</b>
Nécessaires à l'installation	<b><u>31073.00.000</u></b>

## DESSIN TECHNIQUE

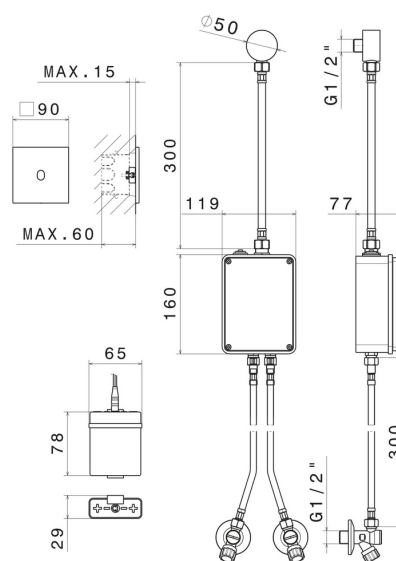

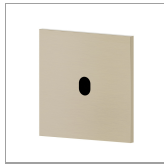

## **SENSITIVE**

**66704.59.098**

Commande électronique murale, compatible avec un dispositif à poser, mural ou au plafond -  
finition PVD Brushed Pale Gold

### **FINITIONS DISPONIBLES**

---



**59.098**

PVD Brushed Pale Gold



**01.014**

finition Matt White



**01.093**

finition Matt Black



**21.018**

finition Chrome



**47.083**

finition Groove Bronze



**58.061**

finition PVD Copper Bronze



**58.063**

finition PVD Gun Metal



**59.064**

finition PVD Brushed Gun Metal



**59.066**

finition PVD Brushed steel



**59.067**

finition PVD Brushed Copper Bronze



**59.097**

finition PVD Brushed Gold



**61.020**

finition PVD Glossy Gold

 **MO.070**  
finition Titanium Satin

 **MO.071**  
finition Gold Satin

 **MO.072**  
finition Copper Satin

 **MO.075**  
finition Copper Glossy

 **MO.077**  
finition Carbon Satin