

SENSITIVE

66709E.59.066

Commande électronique murale, compatible avec un dispositif à poser, mural ou au plafond - finition PVD Brushed steel

Réglage de la température et du débit avec robinets d'arrêt (inclus).
Commande d'ouverture à infrarouge ON-OFF manuelle, arrêt programmé à 30". Façade murale.

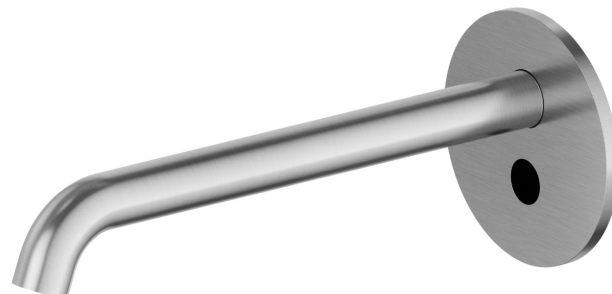
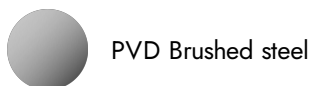

CARACTÉRISTIQUES

Matériau	Laiton
Technologie	Save Water
Installation	Boîte d'encastrement mural
Type de perçage	Monotrou
Mitigeur d'eau	Mécanique
Nécessaires à l'installation	<u>31074.00.000</u>

DESSIN TECHNIQUE

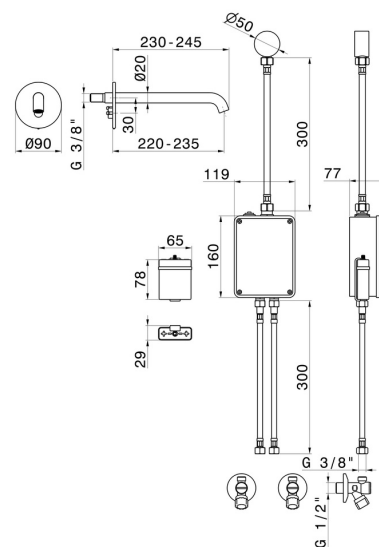



SENSITIVE

66709E.59.066

Commande électronique murale, compatible avec un dispositif à poser, mural ou au plafond -
finition PVD Brushed steel

FINITIONS DISPONIBLES



59.066

PVD Brushed steel



01.014

finition Matt White



01.093

finition Matt Black



21.018

finition Chrome



47.083

finition Groove Bronze



58.061

finition PVD Copper Bronze



58.063

finition PVD Gun Metal



59.064

finition PVD Brushed Gun Metal



59.067

finition PVD Brushed Copper Bronze



59.097

finition PVD Brushed Gold



59.098

finition PVD Brushed Pale Gold





61.020

finition PVD Glossy Gold

 **MO.070**
finition Titanium Satin

 **MO.071**
finition Gold Satin

 **MO.072**
finition Copper Satin

 **MO.075**
finition Copper Glossy

 **MO.077**
finition Carbon Satin