

SENSITIVE

66702.M0.070

Commande électronique pour montage sur plan, compatible avec un dispositif à poser, mural ou au plafond - finition Titanium Satin

Réglage de la température et du débit avec robinets d'arrêt (inclus).
Commande d'ouverture à infrarouge ON-OFF manuelle, arrêt programmé à 30"



Titanium Satin

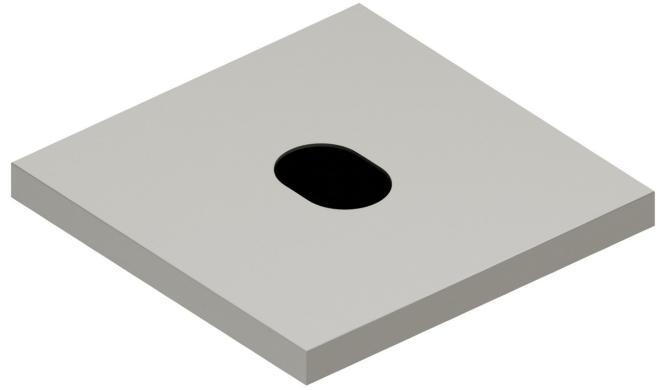

CARACTÉRISTIQUES

Matériau	Laiton
Installation	À poser
Type de commande	Commande électronique

DESSIN TECHNIQUE

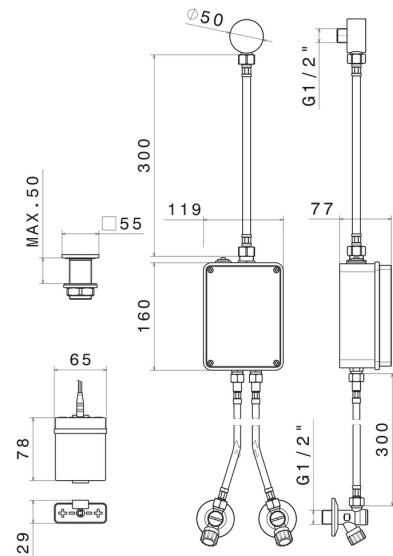

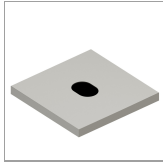

SENSITIVE

66702.M0.070

Commande électronique pour montage sur plan, compatible avec un dispositif à poser, mural ou au plafond - finition Titanium Satin

FINITIONS DISPONIBLES



M0.070

Titanium Satin



01.014

finition Matt White



01.093

finition Matt Black



21.018

finition Chrome



47.083

finition Groove Bronze



58.061

finition PVD Copper Bronze



58.063

finition PVD Gun Metal



59.064

finition PVD Brushed Gun Metal



59.066

finition PVD Brushed steel



59.067

finition PVD Brushed Copper Bronze



59.097

finition PVD Brushed Gold



59.098

finition PVD Brushed Pale Gold

 **61.020**
finition PVD Glossy Gold

 **M0.071**
finition Gold Satin

 **M0.072**
finition Copper Satin

 **M0.075**
finition Copper Glossy

 **M0.077**
finition Carbon Satin