

IONIKA SUPREME

72901.01.093

Mélangeur 3 trous de lavabo. Têtes céramique 1/2" - finition
Matt Black

Sans vidage



CARACTÉRISTIQUES

Matériau	Laiton/Marbre
Technologie	Save Water
Installation	À poser
Type de perçage	3 trous
Vidage	Sans vidage
Mitigeur d'eau	Mécanique

DESSIN TECHNIQUE

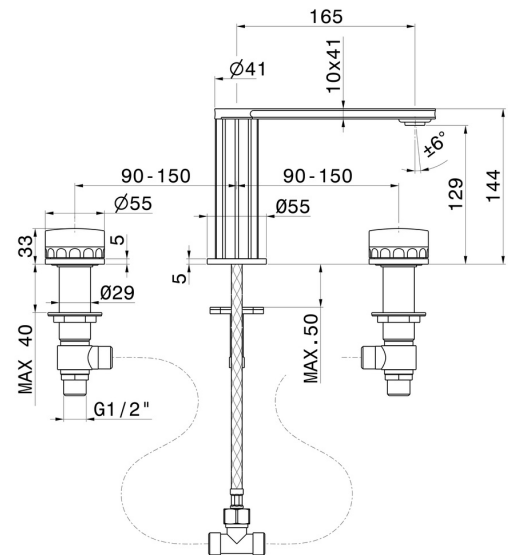



IONIKA SUPREME

72901.01.093

Mélangeur 3 trous de lavabo. Têtes céramique 1/2" - finition Matt Black

FINITIONS DISPONIBLES



01.093

Matt Black



01.014

finition Matt White



21.018

finition Chrome



59.064

finition PVD Brushed Gun Metal



59.066

finition PVD Brushed steel



59.067

finition PVD Brushed Copper Bronze



59.098

finition PVD Brushed Pale Gold



61.020

finition PVD Glossy Gold