

IONIKA SUPREME

72901.59.098

Mélangeur 3 trous de lavabo. Têtes céramique 1/2" - finition PVD Brushed Pale Gold

Sans vidage



PVD Brushed Pale Gold



CARACTÉRISTIQUES

Matériau	Laiton/Marbre
Technologie	Save Water
Installation	À poser
Type de perçage	3 trous
Vidage	Sans vidage
Mitigeur d'eau	Mécanique

DESSIN TECHNIQUE

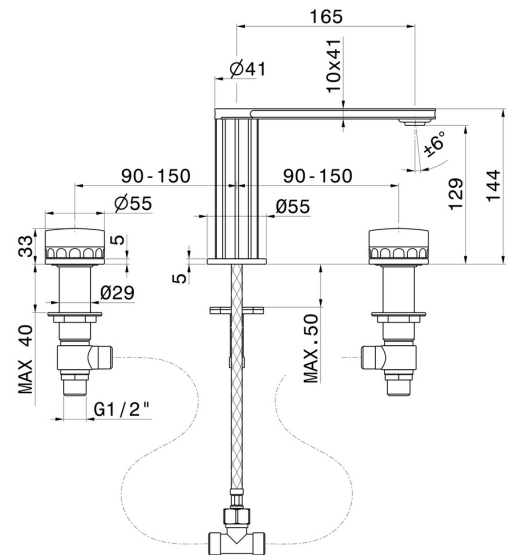



IONIKA SUPREME

72901.59.098

Mélangeur 3 trous de lavabo. Têtes céramique 1/2" - finition PVD Brushed Pale Gold

FINITIONS DISPONIBLES



59.098

PVD Brushed Pale Gold



01.014

finition Matt White



01.093

finition Matt Black



21.018

finition Chrome



59.064

finition PVD Brushed Gun Metal



59.066

finition PVD Brushed steel



59.067

finition PVD Brushed Copper Bronze



61.020

finition PVD Glossy Gold