

70032.M0.071

Mélangeur bord de baignoire avec jet à cascade - finition Gold Satin

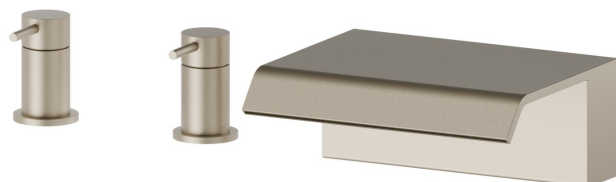

CARACTÉRISTIQUES

Matériau	Laiton
Installation	Bord de baignoire
Mitigeur d'eau	Mécanique
Jets	Jet à cascade

DESSIN TECHNIQUE

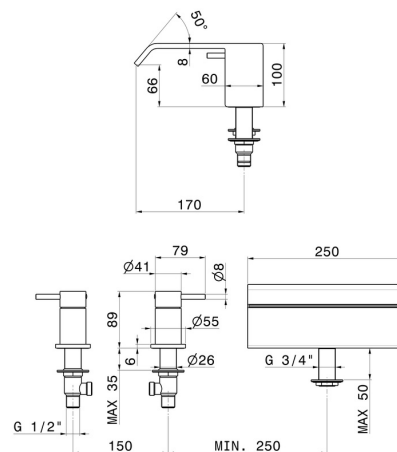

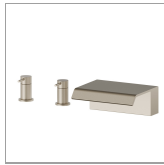



70032.M0.071

Mélangeur bord de baignoire avec jet à cascade - finition Gold Satin

FINITIONS DISPONIBLES

 **M0.071**
Gold Satin

 **01.014**
finition Matt White

 **01.093**
finition Matt Black

 **21.018**
finition Chrome

 **47.083**
finition Groove Bronze

 **59.064**
finition PVD Brushed Gun Metal

 **59.066**
finition PVD Brushed steel

 **59.067**
finition PVD Brushed Copper Bronze

 **59.097**
finition PVD Brushed Gold

 **59.098**
finition PVD Brushed Pale Gold

 **M0.070**
finition Titanium Satin

 **M0.072**
finition Copper Satin



MO.075

finish Copper Glossy



MO.077

finish Carbon Satin