

# X-STEEL 316

**69626X.59.064**

Mitigeur bidet - finition PVD Brushed Gun Metal

Sans vidage



PVD Brushed Gun Metal



## CARACTÉRISTIQUES

Matériau	<b>Acier inox</b>
Technologie	<b>Save Water</b>
Installation	<b>À poser</b>
Type de perçage	<b>Monotrou</b>
Type de commande	<b>Monocommande</b>
Vidage	<b>Sans vidage</b>
Mitigeur d'eau	<b>Mécanique</b>

## DESSIN TECHNIQUE

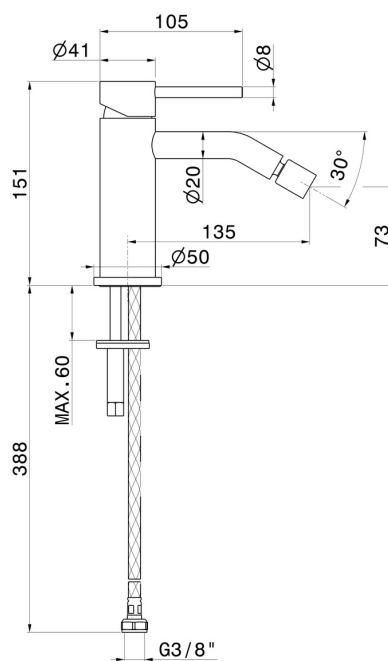



**X-STEEL 316**

**69626X.59.064**

Mitigeur bidet - finition PVD Brushed Gun Metal

**FINITIONS DISPONIBLES**

---



**59.064**

PVD Brushed Gun Metal



**50.050**

finition Stainless Steel



**59.067**

finition PVD Brushed Copper Bronze



**59.097**

finition PVD Brushed Gold



**59.098**

finition PVD Brushed Pale Gold