

## 69474E.M0.072

Mitigeur encastré 2 sorties avec inverseur (entrées et sorties de 1/2"). Façade murale. Ø70 - finition Copper Satin

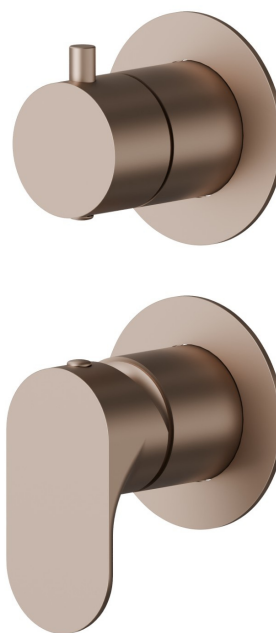

### CARACTÉRISTIQUES

Matériau	<b>Laiton</b>
Installation	<b>Boîte d'encastrement mural</b>
Type de commande	<b>Monocommande</b>
Type d'inverseur	<b>Inverseur mécanique</b>
Sorties	<b>2 Sorties</b>
Nécessaires à l'installation	<b><u>31087.00.000</u></b>

### DESSIN TECHNIQUE

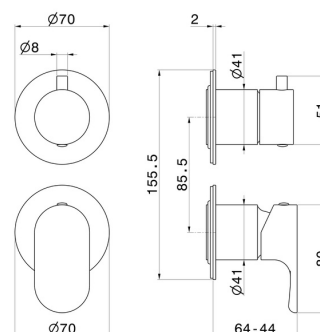

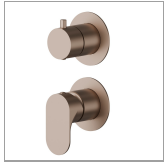

**69474E.M0.072**

Mitigeur encastré 2 sorties avec inverseur (entrées et sorties de 1/2"). Façade murale. Ø70 -  
finition Copper Satin

## FINITIONS DISPONIBLES

---

 **M0.072**  
Copper Satin

 **01.014**  
finition Matt White

 **01.093**  
finition Matt Black

 **21.018**  
finition Chrome

 **M0.070**  
finition Titanium Satin

 **M0.071**  
finition Gold Satin

 **M0.075**  
finition Copper Glossy