

69474E.M0.075

Mitigeur encastré 2 sorties avec inverseur (entrées et sorties de 1/2"). Façade murale. Ø70 - finition Copper Glossy

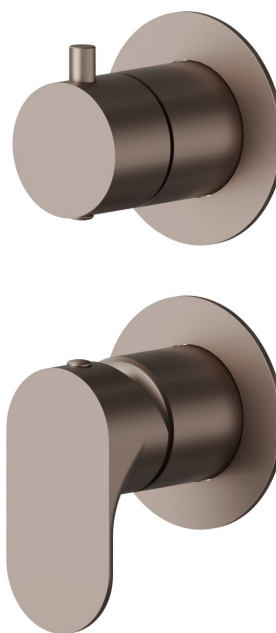

CARACTÉRISTIQUES

Matériau	Laiton
Installation	Boîte d'encastrement mural
Type de commande	Monocommande
Type d'inverseur	Inverseur mécanique
Sorties	2 Sorties
Nécessaires à l'installation	<u>31087.00.000</u>

DESSIN TECHNIQUE

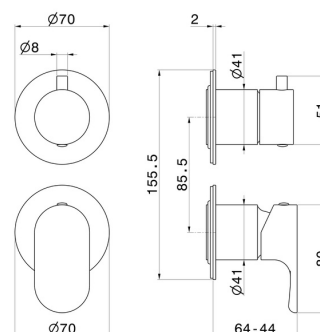

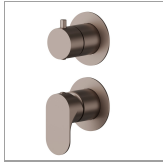



69474E.M0.075

Mitigeur encastré 2 sorties avec inverseur (entrées et sorties de 1/2"). Façade murale. Ø70 -
finition Copper Glossy

FINITIONS DISPONIBLES

 **M0.075**
Copper Glossy

 **01.014**
finition Matt White

 **01.093**
finition Matt Black

 **21.018**
finition Chrome

 **M0.070**
finition Titanium Satin

 **M0.071**
finition Gold Satin

 **M0.072**
finition Copper Satin