

## 4275E.59.067

Mitigeur encastré une sortie (entrées et sorties de 1/2") et boîte d'encastrement. Façade murale - finition PVD Brushed Copper Bronze

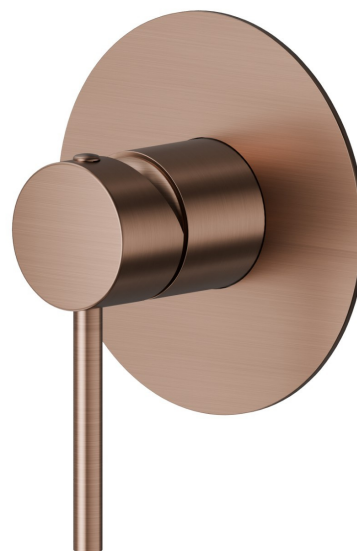

### CARACTÉRISTIQUES

Matériau	<b>Laiton</b>
Installation	<b>Boîte d'encastrement mural</b>
Type de commande	<b>Monocommande</b>
Sorties	<b>1 Sortie</b>
Mitigeur d'eau	<b>Mécanique</b>
Nécessaires à l'installation	<b><u>31085.00.000</u></b>

### DESSIN TECHNIQUE

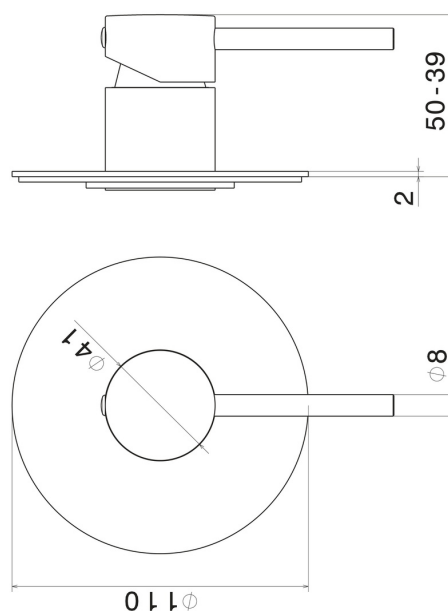

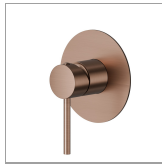

**4275E.59.067**

Mitigeur encastré une sortie (entrées et sorties de 1/2") et boîte d'encastrement. Façade murale -  
finition PVD Brushed Copper Bronze

**FINITIONS DISPONIBLES**

---

 **59.067**  
PVD Brushed Copper Bronze

 **01.014**  
finition Matt White

 **01.093**  
finition Matt Black

 **21.018**  
finition Chrome

 **47.083**  
finition Groove Bronze

 **58.061**  
finition PVD Copper Bronze

 **58.063**  
finition PVD Gun Metal

 **59.064**  
finition PVD Brushed Gun Metal

 **59.066**  
finition PVD Brushed steel

 **59.097**  
finition PVD Brushed Gold

 **59.098**  
finition PVD Brushed Pale Gold

 **61.020**  
finition PVD Glossy Gold

 **MO.070**  
finition Titanium Satin

 **MO.071**  
finition Gold Satin

 **MO.072**  
finition Copper Satin

 **MO.075**  
finition Copper Glossy

 **MO.077**  
finition Carbon Satin