

69475E.M0.071

Mitigeur encastré une sortie (entrées et sorties de 1/2") et boîte d'encastrement. Façade murale - finition Gold Satin

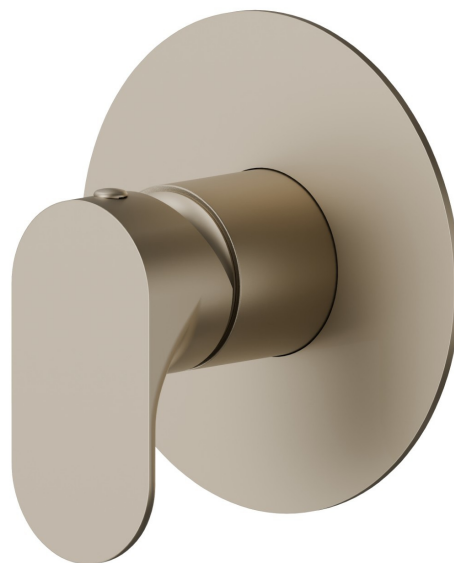

CARACTÉRISTIQUES

Matériau	Laiton
Installation	Boîte d'encastrement mural
Type de commande	Monocommande
Sorties	1 Sortie
Nécessaires à l'installation	<u>31085.00.000</u>

DESSIN TECHNIQUE

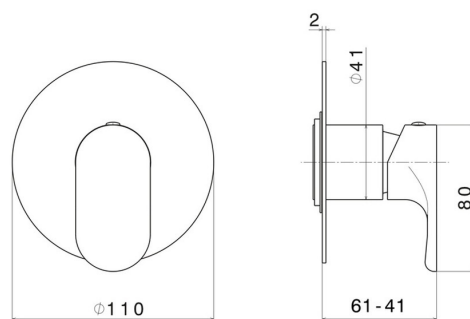





69475E.M0.071

Mitigeur encastré une sortie (entrées et sorties de 1/2") et boîte d'encastrement. Façade murale -
finition Gold Satin

FINITIONS DISPONIBLES

 **M0.071**
Gold Satin

 **01.014**
finition Matt White

 **01.093**
finition Matt Black

 **21.018**
finition Chrome

 **M0.070**
finition Titanium Satin

 **M0.072**
finition Copper Satin

 **M0.075**
finition Copper Glossy