

X-STEEL 316

74313X.59.067

Mitigeur lavabo - finition PVD Brushed Copper Bronze

Sans vidage



PVD Brushed Copper Bronze



CARACTÉRISTIQUES

Matériau	Acier inox
Technologie	Save Water
Installation	À poser
Version	Standard
Type de perçage	Monotrou
Type de commande	Monocommande
Vidage	Sans vidage
Mitigeur d'eau	Mécanique

DESSIN TECHNIQUE

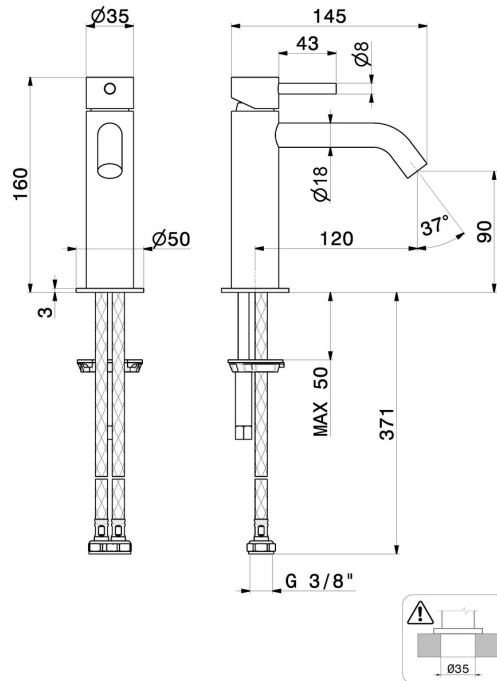



X-STEEL 316

74313X.59.067

Mitigeur lavabo - finition PVD Brushed Copper Bronze

FINITIONS DISPONIBLES



59.067

PVD Brushed Copper Bronze



50.050

finition Stainless Steel



59.064

finition PVD Brushed Gun Metal



59.097

finition PVD Brushed Gold



59.098

finition PVD Brushed Pale Gold