

X-STEEL 316

74313X.59.097

Mitigeur lavabo - finition PVD Brushed Gold

Sans vidage



PVD Brushed Gold



CARACTÉRISTIQUES

Matériau	Acier inox
Technologie	Save Water
Installation	À poser
Version	Standard
Type de perçage	Monotrou
Type de commande	Monocommande
Vidage	Sans vidage
Mitigeur d'eau	Mécanique

DESSIN TECHNIQUE

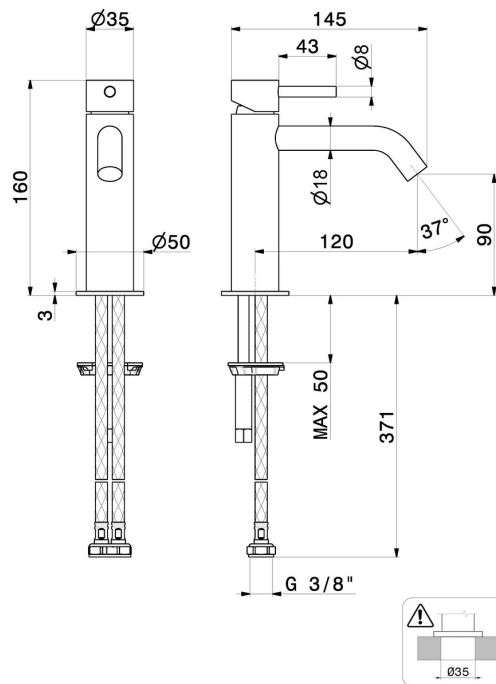



X-STEEL 316

74313X.59.097

Mitigeur lavabo - finition PVD Brushed Gold

FINITIONS DISPONIBLES



59.097

PVD Brushed Gold



50.050

finition Stainless Steel



59.064

finition PVD Brushed Gun Metal



59.067

finition PVD Brushed Copper Bronze



59.098

finition PVD Brushed Pale Gold