

X-STEEL 316

74313X.59.098

Mitigeur lavabo - finition PVD Brushed Pale Gold

Sans vidage



PVD Brushed Pale Gold



CARACTÉRISTIQUES

Matériau	Acier inox
Technologie	Save Water
Installation	À poser
Version	Standard
Type de perçage	Monotrou
Type de commande	Monocommande
Vidage	Sans vidage
Mitigeur d'eau	Mécanique

DESSIN TECHNIQUE

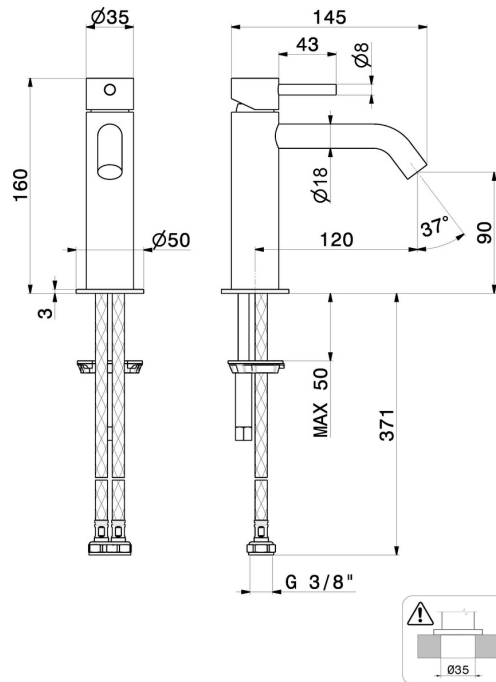



X-STEEL 316

74313X.59.098

Mitigeur lavabo - finition PVD Brushed Pale Gold

FINITIONS DISPONIBLES



59.098

PVD Brushed Pale Gold



50.050

finition Stainless Steel



59.064

finition PVD Brushed Gun Metal



59.067

finition PVD Brushed Copper Bronze



59.097

finition PVD Brushed Gold