

LINFA II

69468E.M0.077

Mitigeur mural 2 sorties avec douchette et inverseur. Ø70 -
 finition Carbon Satin

Façade murale



Carbon Satin



CARACTÉRISTIQUES

Matériau	Laiton
Technologie	Save Water
Installation	Boîte d'encastrement mural
Type de perçage	3 trous
Type d'inverseur	Inverseur mécanique
Mitigeur d'eau	Mécanique
Nécessaires à l'installation	<u>31086.00.000</u>

DESSIN TECHNIQUE

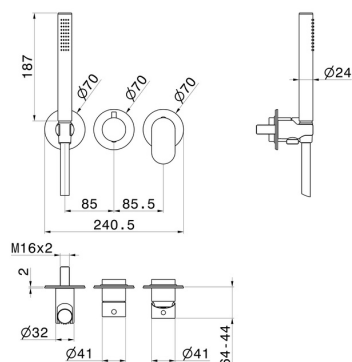

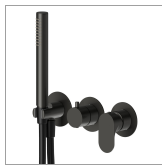

LINFA II

69468E.MO.077

Mitigeur mural 2 sorties avec douchette et inverseur. Ø70 - finition Carbon Satin

FINITIONS DISPONIBLES

 **MO.077**
Carbon Satin

 **01.014**
finition Matt White

 **01.093**
finition Matt Black

 **21.018**
finition Chrome

 **MO.070**
finition Titanium Satin

 **MO.071**
finition Gold Satin

 **MO.072**
finition Copper Satin

 **MO.075**
finition Copper Glossy