

## 70455E.01.093

Mitigeur thermostatique à encastrer 3 sorties, avec commande pour le réglage de la température et boutons on/off. Façade murale. Ø190 - finition Matt Black



### CARACTÉRISTIQUES

Matériau	<b>Laiton</b>
Installation	<b>Boîte d'encastrement mural</b>
Sorties	<b>3 Sorties</b>
Mitigeur d'eau	<b>Thermostatique</b>
Nécessaires à l'installation	<b><u>27752.00.000</u></b>

### DESSIN TECHNIQUE

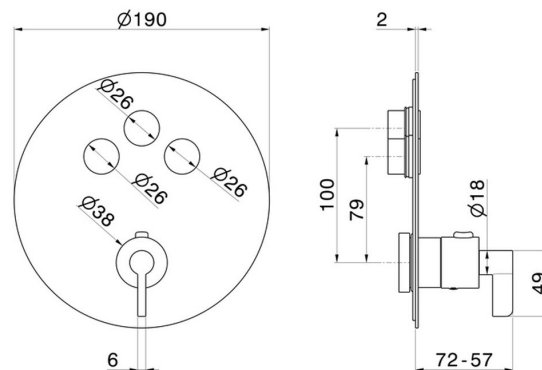



**70455E.01.093**

Mitigeur thermostatique à encastrer 3 sorties, avec commande pour le réglage de la température et boutons on/off. Façade murale. Ø190 - finition Matt Black

**FINITIONS DISPONIBLES**

---



**01.093**

Matt Black



**21.018**

finition Chrome



**47.083**

finition Groove Bronze



**58.061**

finition PVD Copper Bronze



**58.063**

finition PVD Gun Metal



**59.098**

finition PVD Brushed Pale Gold



**61.020**

finition PVD Glossy Gold