

70455E.61.020

Mitigeur thermostatique à encastrer 3 sorties, avec commande pour le réglage de la température et boutons on/off. Façade murale. Ø190 - finition PVD Glossy Gold

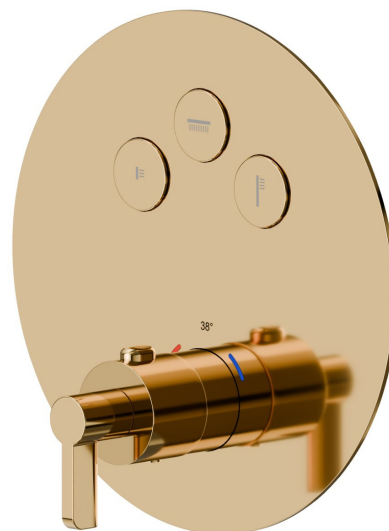

CARACTÉRISTIQUES

Matériau	Laiton
Installation	Boîte d'encastrement mural
Sorties	3 Sorties
Mitigeur d'eau	Thermostatique
Nécessaires à l'installation	<u>27752.00.000</u>

DESSIN TECHNIQUE

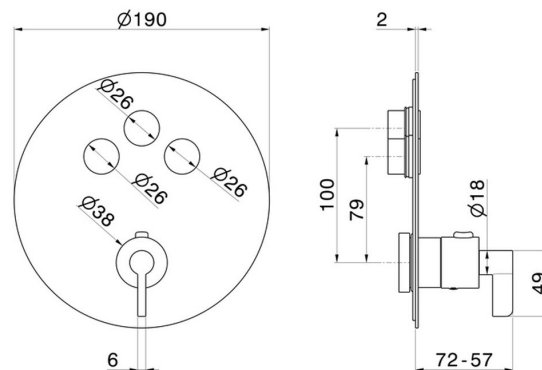

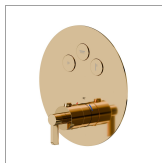

70455E.61.020

Mitigeur thermostatique à encastrer 3 sorties, avec commande pour le réglage de la température et boutons on/off. Façade murale. Ø190 - finition PVD Glossy Gold

FINITIONS DISPONIBLES



61.020

PVD Glossy Gold



01.093

finition Matt Black



21.018

finition Chrome



47.083

finition Groove Bronze



58.061

finition PVD Copper Bronze



58.063

finition PVD Gun Metal



59.098

finition PVD Brushed Pale Gold